



**11** Other Models

**10**  
Inquiry Table

**03**  
Definition  
of Terms

**09**  
Position Feedback

**08**  
Dimension

# Contents

Configs. **04**  
Load & Speed

**07**  
Rear Mount. End

**05**  
Chart of Load, Speed  
and Current

**06**  
Front Mount. End

Dear Customers,

What a big world ! But thanks to crazy technology, it's been getting smaller than ever, so that we can meet here from all corners of the world. It's our pleasure to have opportunities to provide you with a variety of products and services to help with the implementation of your amazing designs.

We present our products thoroughly in front of you by using refined parameters and words, so that you can find the most suitable solution.

Next, we will take you to a deeper understanding of Hongba's products. Please read this datasheet carefully. You are also welcome to leave valuable comments and suggestions to help Hongba improve itself continuously.

HB Engineer Team

## Definition of Terms

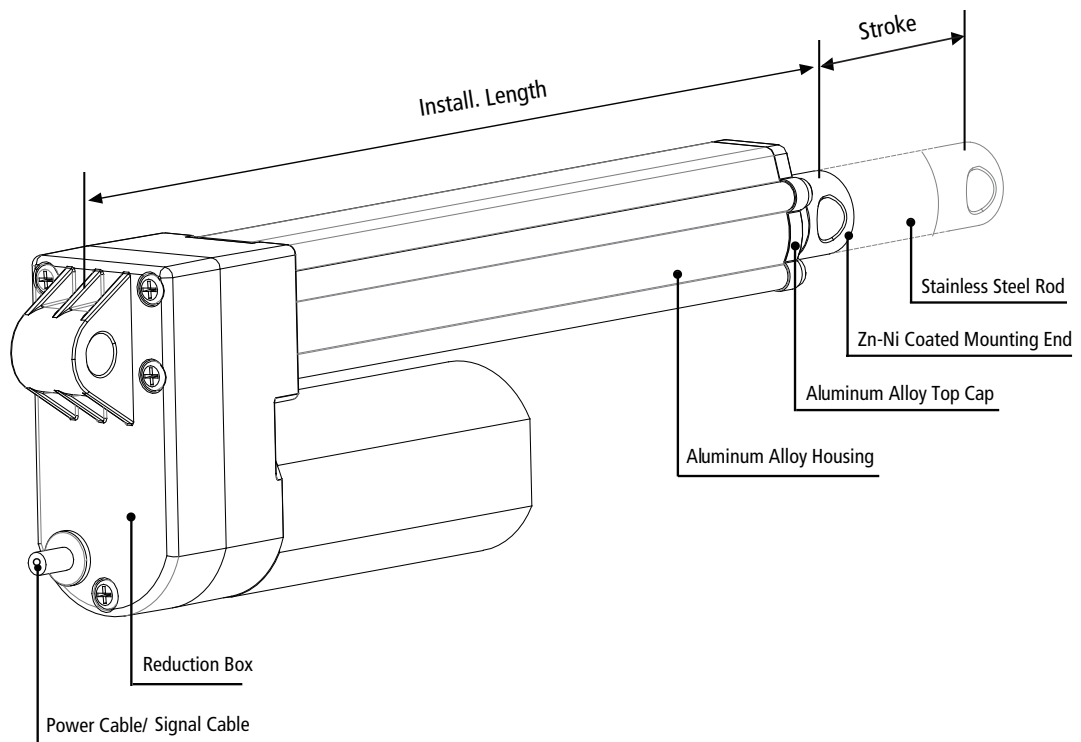

Stroke	How far the rod extends outwards from the body. The difference between fully extended length and fully retracted length. [Customizable]
Install. Length	The fully closed size. [Customizable]
Front Mount. End	Optional.
Rear Mount. End	Optional.
Mount. Holes	Can be rotated by 90°.
Dynamic Force	The max force that actuator is able to carry when it is moving.
Selflocking	The max force that linear actuator is able to hold when it stops.
Weather Protection	IP XX. The first digit: dust protection. The second digit: liquid protection. Please refer to [Table 1].
Duty Cycle	Continuous working time 'a', rest time 'b'. Duty cycle is $a/(a+b) \times 100\%$ . Please refer to [Table 1].
Speed	Include free-load speed and full-load speed.
Hall Sensor	Provide pulse signals. Displacement measurement is achieved through pulse counting, and the phase difference of the waveform can be used to identify the rotation direction of motor. Check [Table 1] to see if it is available.
Potentiometer	Potentiometer is a three-terminal variable resistor with a rotating contact which is used to measure the displacement of actuators. Check [Table 1] to see if it is available.
Manual Override	Can be used to extend or retract the actuator without power for emergency. Check [Table 1] to see if it is available.

## Configs.

Color	<input checked="" type="checkbox"/> Silver	<input type="checkbox"/> Black	<input type="checkbox"/> Customized			
Lead Screw	<input checked="" type="checkbox"/> Acme Screw	<input type="checkbox"/> Ball Screw				
Operation Mode	<input checked="" type="checkbox"/> Electrical	<input type="checkbox"/> Electrical + Manual				
Application	<input checked="" type="checkbox"/> Industrial	<input checked="" type="checkbox"/> Furniture	<input checked="" type="checkbox"/> Medical			
Operational Temp.	<input type="checkbox"/> 5 to 40°C	<input checked="" type="checkbox"/> -10 to 65°C	<input checked="" type="checkbox"/> -40 to 65°C			
Operating Noise	<input checked="" type="checkbox"/> ≤45 dB	<input type="checkbox"/> ≤50 dB	<input type="checkbox"/> ≤65 dB			
Stroke Range	<input checked="" type="checkbox"/> 50-600mm	<input type="checkbox"/> 600-1,000mm				
Dynamic Load	<input type="checkbox"/> ≤1,200N	<input checked="" type="checkbox"/> ≤2,000N	<input type="checkbox"/> ≤4,000N	<input type="checkbox"/> ≤7,000N	<input type="checkbox"/> ≤12,000N	<input type="checkbox"/> ≤20,000N
Duty Cycle	<input type="checkbox"/> 10%	<input checked="" type="checkbox"/> 20%*	<input type="checkbox"/> 25%	<input type="checkbox"/> 50%	<input type="checkbox"/> 100%	
Motor Type	<input checked="" type="checkbox"/> Brushed DC	<input type="checkbox"/> Stepper Motor	<input type="checkbox"/> Brushless	<input type="checkbox"/> Servo Motor		
Overload Protection	<input checked="" type="checkbox"/> None	<input type="checkbox"/> Clutch	<input type="checkbox"/> Electronic	<input type="checkbox"/> Thermistor		
Weather Protection	<input type="checkbox"/> IP20	<input type="checkbox"/> IP43	<input type="checkbox"/> IP54	<input type="checkbox"/> IP65	<input checked="" type="checkbox"/> IP66	
Position Feedback	<input checked="" type="checkbox"/> None	<input checked="" type="checkbox"/> Endstop Signal	<input checked="" type="checkbox"/> Hall Sensor	<input type="checkbox"/> Potentiometer	<input type="checkbox"/> Encoder	<input checked="" type="checkbox"/> Reed Switches
Input Voltage	<input checked="" type="checkbox"/> 12VDC	<input checked="" type="checkbox"/> 24VDC	<input checked="" type="checkbox"/> 36VDC	<input checked="" type="checkbox"/> 48VDC	<input type="checkbox"/> 110VAC	<input type="checkbox"/> 220VAC



\* Don't exceed two minutes continuous working when with full load and 20°C.

Options for DJ825     Other Models

[ Table 1 ]

## Parameters

Fill in code:

Code	Max. Dynamic Load <sup>②</sup>	Max. Self-locking	Reduction Ratio	Pitch	Speed±10% <sup>①</sup> (mm/s)		Max. Stroke <sup>③</sup>
	(N)				(N)	-	(mm)
A	2,000	3,000	32.6:1	3.17	6.0	5.0	600
B	1,500	2,500	32.6:1	5	10.0	7.0	600
C	1,000	1,500	32.6:1	7.5	15.0	11.0	600

[ Table 2 ]

- ① Measurements are made with actuators in connection with stable power supplies and ambient temperature at 20°C.
- ② For example, when real load is 1400N, choosing code (B) is fine. Of course, you can also choose (A) which come with more load buffer, higher safety factor and longer product service time.
- ③ There are many factors affecting the "customizable maximum stroke", such as load, speed, force direction, etc., so the real application scenarios should be considered. If the parameters you required are not listed, please contact our sales engineers.

**1 = 12v**

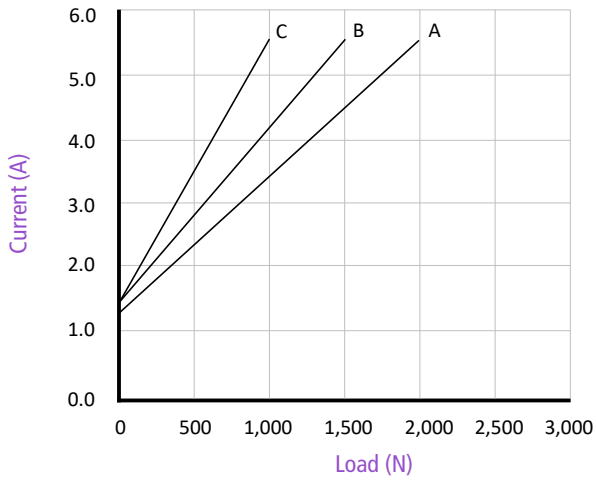

**2 = 24v**

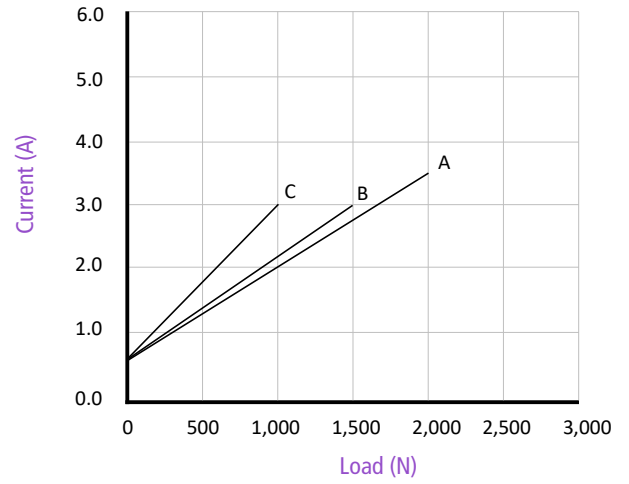

**3 = 36v**

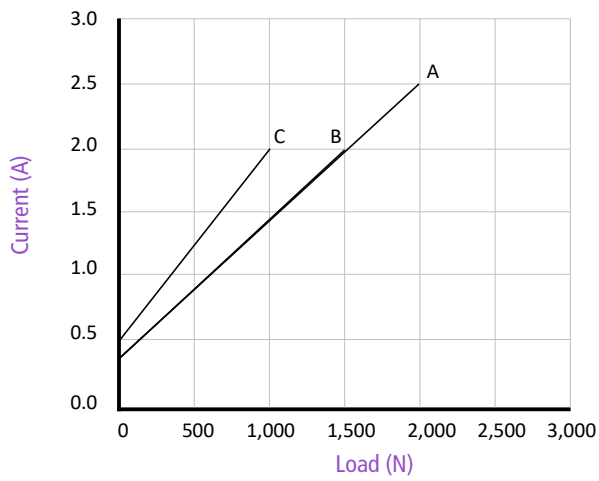

**4 = 48v**

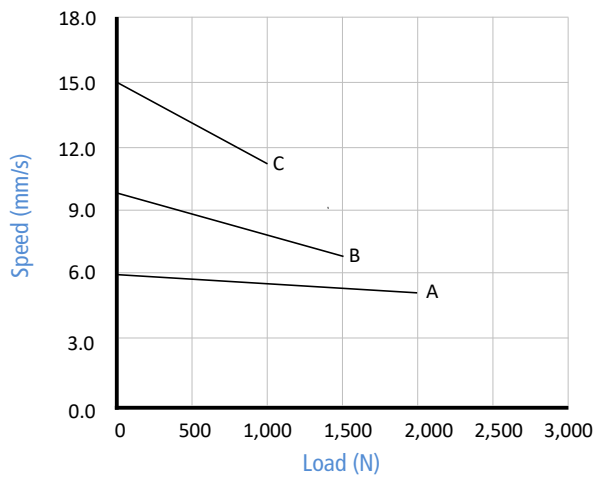
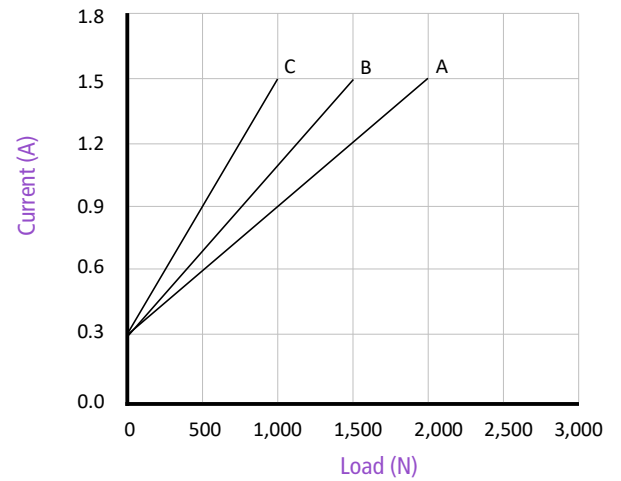

\* Measurements are made with actuators in connection with stable power supplies and ambient temperature at 20°C.

## Front Mounting End

1. Please contact our sales team if none of the options below meet your requirements.

Fill in code:

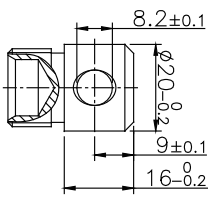

F01

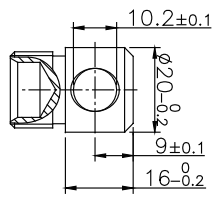

F02

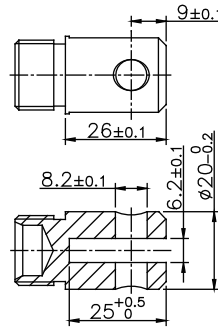

F03

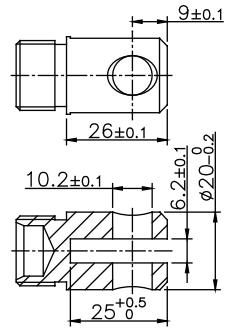

F04

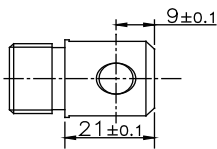

F05

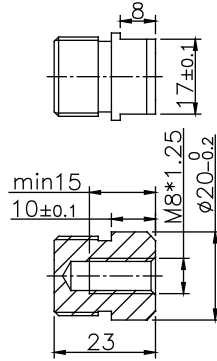

F06

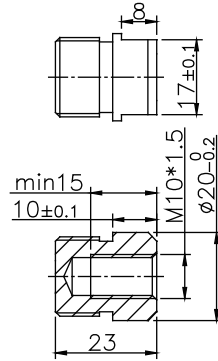

F07

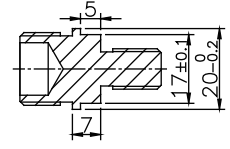

F08

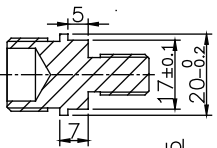
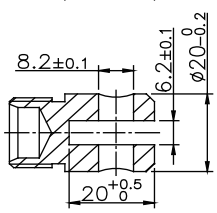

F09

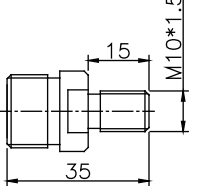

2. Start of Installation Length

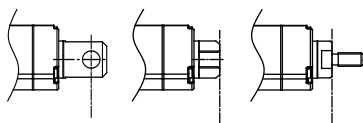

3. Hole Directions

Fill in code:

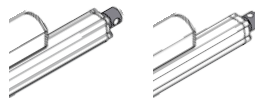

1 = 90°

2 = 0°

# Rear Mounting End

1. Please contact our sales team if none of the options below meet your requirements.

Fill in code:

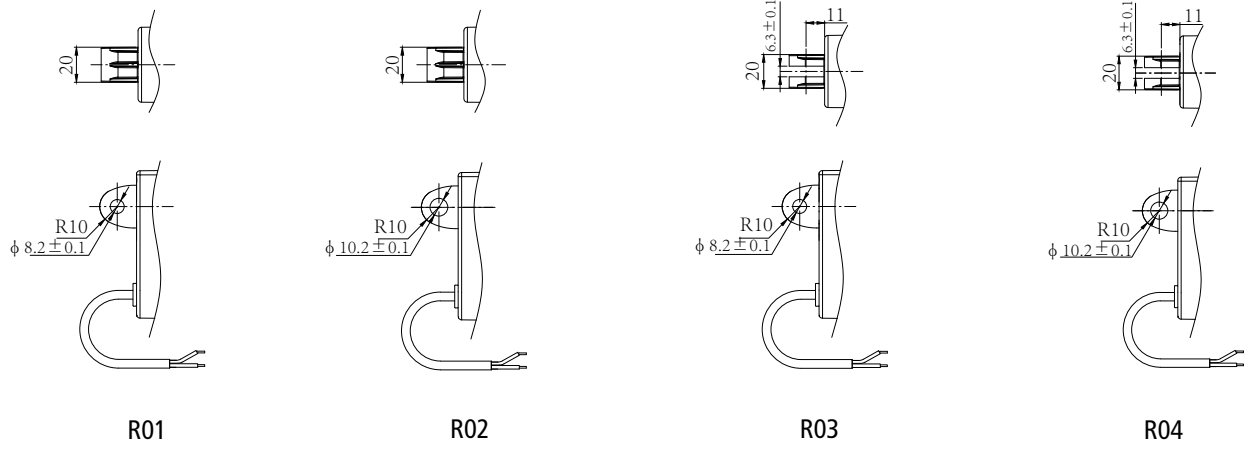

2. End of Installation Length

3. Hole Directions

Fill in code:

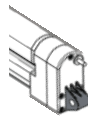
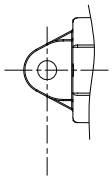

1 = 90°

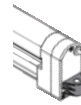

2 = 0°

\* not applied to R01 & R02

**1. Overall Size**

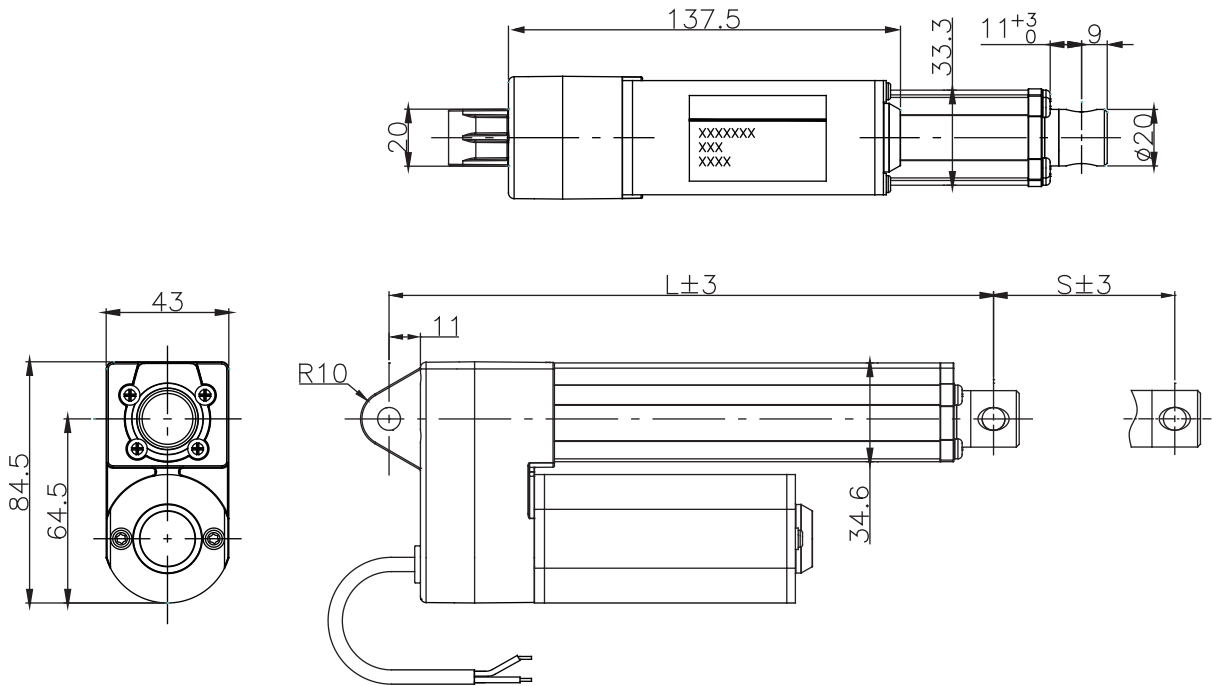

**2. Installation Size (L≥A+B+C)**

<b>A. Mounting Ends</b>	Rear Ends
Front Ends	R01- R04
F01, F02, F05-F09	S+115
F03, F04	S+123

[Table 3]

<b>B. Stroke Range</b>	mm
30 - 299	+ 0
300 - 499	+ 30
≥ 500	+ 60

[Table 4]

<b>C. Reed Switch</b>	mm
Optional	+ 10

[Table 5]

**Example**

Front Mount. End	Rear Mount. End	Stroke	A	B	w/o Reed Switch	L ≥ A+B+C
F04	R01	300	300+123	+30	C = 0	≥ 453

[Table 6]



# Signal Feedback

Fill in code: 0 = No Signal Feedback  
 1 = Endstop Signal  
 2 = Hall Effect Sensor  
 3 = Reed Switches

## 0. Limit Switches

Standard DJ825 comes with limit switches that shut off the motor automatically at the end of its travel.

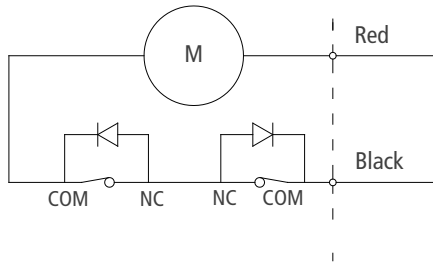

Wiring		
	Black	Red
Extend	-	+
Retract	+	-

[Table 6]

## 1. Endstop Signal

The actuator can be equipped with endstop signals output, but it will not auto-stop at neither end of the travel.

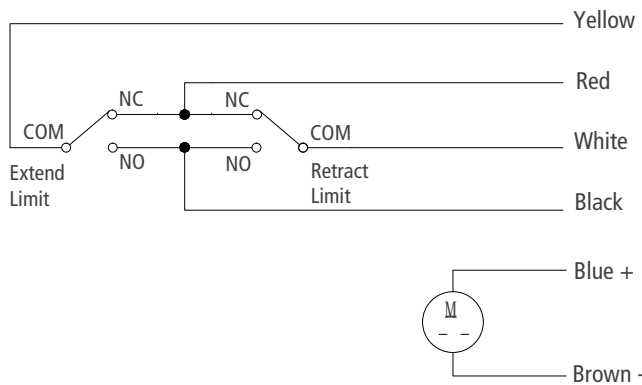

Power Wire Coding		
	Brown	Blue
Extend	-	+
Retract	+	-

Signal Wire Coding	
Black	Extend / Retract limit, N.O.
Red	Extend / Retract limit, N.C.
Yellow	Extend limit. COM.
White	Retract limit. COM.

[Table 7]

## 2. Hall Effect Sensor (standard dual-sensor)

Code	Pulse Equivalent Per Sensor (pulse/mm)	
	1 pole pair	4 pole pairs (standard)
A	10.28	41.10
B	6.53	26.10
C	4.35	17.40

[Table 8]

### Wire Coding

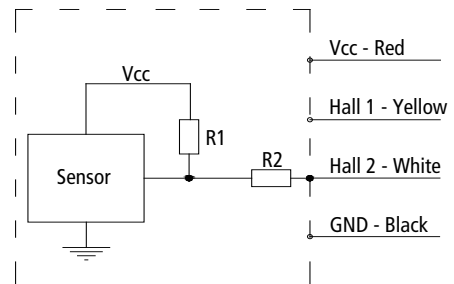

\* Power supply (V)= 5~15

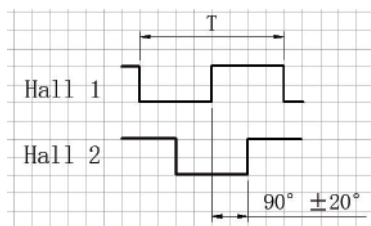

Oscillogram

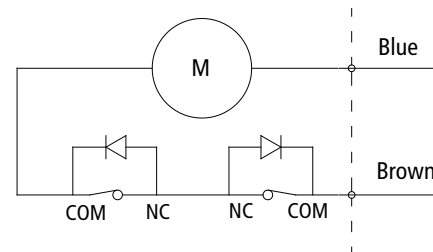

Internal Motor Wiring

## 3. Reed switch

Standard N.O. contact. Optional N.C. contact.

## Inquiry Table

RESET

<input style="width: 100%; height: 100%;" type="text"/>	Voltage	1 = 12VDC    2 = 24VDC    3 = 36VDC    4 = 48VDC
<input style="width: 100%; height: 100%;" type="text"/>	Load & Speed	See [Table 2]
<input style="width: 100%; height: 100%;" type="text"/>	Stroke (mm)	Please contact us if the stroke you required is out of range.
<input style="width: 100%; height: 100%;" type="text"/>	Install. Length (mm)	See page Table [3] - [5]
<input style="width: 100%; height: 100%;" type="text"/>	Front Mount. End	F01 - F09, or FX = Custom
<input style="width: 100%; height: 100%;" type="text"/>	Rear Mount. End	R01 - R04, or RX = Custom
<input style="width: 100%; height: 100%;" type="text"/>	Mount. Hole Direction	Front   1 = 90°    2 = 0°                  Rear   1 = 90°    2 = 0°
<input style="width: 100%; height: 100%;" type="text"/>	Signal Feedback	0 = None    1 = Endstop Signal    2 = Hall Sensor    3 = Reed Switches
<input style="width: 100%; height: 100%;" type="text"/>	Cable Length	1 = 500 mm    2 = 1,000 mm    3 = 2,000 mm    X = Custom
<input style="width: 100%; height: 100%;" type="text"/>	Connector	0 = Tinned Bared Wires                          X = Custom 1 = Match with KZ-series Controller
<input style="width: 100%; height: 100%;" type="text"/>	Working Temperature	1 = -10℃ to 65℃                  2 = -40℃ to 65℃
Application	Working Frequency	Estimated cycles work per day
	End Use	Indoor or outdoor, and please describe your mechanical device.
	Your contact	Company Name Tel.    Email

### Terms of Use

Due to our continuous improving of HB products, Hongba reserves the right to change or modify our products without prior notice, at any time. Therefore, Hongba cannot guarantee the correct and actual status of said information on its products. The user is responsible for determining the suitability of HB products for specific application.

Wuxi Hongba Mechanical Electrical Equipment. Co., Ltd.

Cell:  
Email:  
Tel.: 0510-85436730  
Website: hbactuator.com  
Address: 5 Lijiang Rd. Xinwu District, Wuxi 214028 China

 You may also be interested in...

Model	Load (N)	Stroke (mm)	Speed (mm/s)	Install.Length (mm)	Overall Size (mm)	IP rate	Application
DJ803 (Track)	1,500	50-600	16-32	155	155 x 77.4 x L	IP20	Furniture
DJ823	3,000	50-600	5.0-15	S+155	148.5 x 80 x L	IP54	Furniture Medical Care
DJ810	4,000	50-600	5.0-32	S+150	156 x 83 x L	IP43	Furniture Medical Care
DJ801	6,000	50-600	4.7-28	S+175	156 x 83 x L	IP43	Furniture Medical Care
DJ822	6,000	50-600	5.0-16	S+175	166 x 91 x L	IP54	Furniture Medical Care
DJ806	1,200	50-600	5.5-80	S+105	40 x 75 x L	IP66	Industrial
DJ809	2,000	50-600	5.0-55	S+108	45 x 77.5 x L	IP66	Industrial
* DJ825	2,000	50-600	6-15	S+115	43 x 84.5 x L	IP66	Furniture Medical Care Industrial
DJ820	2,500	50-600	2.5-22	S+120	64.5 x 102 x L	IP66	Furniture Medical Care Industrial
DJ820P	1,000	50-600	25-50	S+140	64.5 x 102 x L	IP66	Industrial
DJ830	4,000	50-600	5.5-35	S+200	76 x 151 x L	IP65	Industrial
DJ830P	7,000	50-600	5.5-35	S+200	76 x 151 x L	IP65	Industrial
DJ808	7,000	50-600	5.5-35	S+250	77 x 151 x L	IP65	Industrial
DJ805G	12,000	50-1,000	6.5-37	S+200	102 x 154 x L	IP66	Industrial

\* You are now reading...

For more information, please visit our website [hbactuator.com](http://hbactuator.com)